

USER MANUAL

ProLite

LCD Monitor

ENGLISH

ProLite XCB3494WQSN

Thank you very much for choosing the iiyama LCD monitor.

We recommend that you take a few minutes to read this comprehensive manual carefully before installing and switching on the monitor. Please keep this manual in a safe place for your future reference.



Dear user, we congratulate you on the purchase of your iiyama LCD.

For details on warranty and locally used pixel policies that apply directly after installation of your product please check the iiyama website.

To report a fault, please contact your local support centre found at <https://iiyama.com>

Things to check before you call the iiyama information line

- | if the power cable is connected securely and turned on?
- | if the display has been turned on?
- | if the signal cable is connected securely and the correct input selected?
- | if the computer has been restarted with the display connected?
- | if the graphics card is correctly installed with the latest drivers possible?
- | if the correct native resolution has been selected via 'Display Properties'?
- | If the R/G/B signal configuration is correct?
- | if the displays On Screen Menu is shown?
- | if the correct brightness and contrast settings have been set?
- | if given display tolerances and compatibility have been considered?
- | if via the On Screen Menu you have performed a Factory Reset/Recall?



Before reporting the screen defect, please prepare the following information/evidence:

- | model number *
- | purchase receipt and serial number *
- | name and address for collection
- | telephone/fax number, for availability during the day
- | convenient collection date (date, time)
- | short description of the defect

Important Note:

If there is no fault found in the collected equipment after inspection, the transferring party shall incur charges for transport and administration.

If you have checked all of the above and there is still no picture, call our information line for assistance in your country.

* see the identification plate on the back of the case.

CE MARKING DECLARATION OF CONFORMITY

This LCD monitor complies with the requirements of the EC/EU Directive 2014/30/EU "EMC Directive", 2014/35/EU "Low Voltage Directive", 2009/125/EC "ErP Directive" and 2011/65/EU "RoHS Directive".

The electro-magnetic susceptibility has been chosen at a level that gives correct operation in residential areas, business and light industrial premises and small-scale enterprises, inside as well as outside of the buildings. All places of operation are characterised by their connection to the public low voltage power supply system.

IYAMA CORPORATION: Wijkmeerstraat 8, 2131 HA Hoofddorp, The Netherlands

Model No. : PL3494WQ



We recommend recycling of used product. Please contact your dealer or iiyama service center. Recycle information is obtained via the Internet, using the address: <https://iiyama.com>

You can access the Web page of different countries from there.

- We reserve the right to change specifications without notice.
- All trademarks used in this user manual are the property of their respective owners.
- Eprel registration number XCB3494WQSN-B5 : 1396054

TABLE OF CONTENTS

| | |
|---|----|
| FOR YOUR SAFETY..... | 1 |
| SAFETY PRECAUTIONS..... | 1 |
| SPECIAL NOTES ON LCD MONITORS..... | 3 |
| CUSTOMER SERVICE..... | 3 |
| CLEANING..... | 3 |
| BEFORE YOU OPERATE THE MONITOR..... | 4 |
| FEATURES..... | 4 |
| CHECKING THE CONTENTS OF THE PACKAGE..... | 4 |
| USING ARM OR STAND..... | 5 |
| FITTING AND REMOVAL OF STAND..... | 6 |
| CONTROLS AND CONNECTORS..... | 8 |
| CONNECTING YOUR MONITOR..... | 9 |
| COMPUTER SETTING..... | 11 |
| ADJUSTING THE HEIGHT AND THE VIEWING ANGLE..... | 11 |
| OPERATING THE MONITOR..... | 12 |
| ADJUSTMENT MENU CONTENTS..... | 13 |
| STANDBY FEATURE..... | 24 |
| TROUBLE SHOOTING..... | 25 |
| RECYCLING INFORMATION..... | 26 |
| APPENDIX..... | 27 |
| SPECIFICATIONS : ProLite XCB3494WQSN-B5..... | 27 |
| DIMENSIONS..... | 28 |
| COMPLIANT TIMING..... | 28 |

FOR YOUR SAFETY

SAFETY PRECAUTIONS

WARNING

STOP OPERATING THE MONITOR WHEN YOU SENSE TROUBLE

If you notice any abnormal phenomena such as smoke, strange sounds or fumes, unplug the monitor and contact your dealer or iiyama service center immediately. Further use may be dangerous and can cause fire or electric shock.

NEVER REMOVE THE CABINET

High voltage circuits are inside the monitor. Removing the cabinet may expose you to the danger of fire or electric shock.

DO NOT PUT ANY OBJECT INTO THE MONITOR

Do not put any solid objects or liquids such as water into the monitor. In case of an accident, unplug your monitor immediately and contact your dealer or iiyama service center. Using the monitor with any object inside may cause fire, electric shock or damage.

INSTALL THE MONITOR ON A FLAT, STABLE SURFACE

The monitor may cause an injury if it falls or is dropped.

DO NOT USE THE MONITOR NEAR WATER

Do not use where water may be splashed or spilt onto the monitor as it may cause fire or electric shock.

OPERATE UNDER THE SPECIFIED POWER SUPPLY

Be sure to operate the monitor only with the specified power supply. Use of an incorrect voltage will cause malfunction and may cause fire or electric shock.

PROTECT THE CABLES

Do not pull or bend the power cable and signal cable. Do not place the monitor or any other heavy objects on the cables. If damaged, the cables may cause fire or electric shock.

ADVERSE WEATHER CONDITIONS

It is advisable not to operate the monitor during a heavy thunder storm as the continual breaks in power may cause malfunction. It is also advised not to touch the plug in these circumstances as it may cause electric shock.

CAUTION

INSTALLATION LOCATION

Do not install the monitor where sudden temperature changes may occur, or in humid, dusty or smoky areas as it may cause fire, electric shock or damage. You should also avoid areas where the sun shines directly on the monitor.

DO NOT PLACE THE MONITOR IN A HAZARDOUS POSITION

The monitor may topple and cause injury if not suitably located. Please also ensure that you do not place any heavy objects on the monitor, and that all cables are routed such that children may not pull the cables and possibly cause injury.

MAINTAIN GOOD VENTILATION

Ventilation slots are provided to keep the monitor from overheating. Covering the slots may cause fire. To allow adequate air circulation, place the monitor at least 10cm (or 4 inches) from any walls. When removing the tilt stand, the ventilation slots on the back side of the monitor can be blocked. This may overheat the monitor and may cause fire or damage. Make sure to allow enough ventilation when removing the tilt stand. Operating the monitor on its back, side, upside down or on a carpet or any other soft material may also cause damage.

DISCONNECT THE CABLES WHEN YOU MOVE THE MONITOR

When you move the monitor, turn off the power switch, unplug the monitor and be sure the signal cable is disconnected. If you do not disconnect them, it may cause fire or electric shock.

UNPLUG THE MONITOR

If the monitor is not in use for a long period of time it is recommended that it is left unplugged to avoid accidents.

HOLD THE PLUG WHEN DISCONNECTING

To disconnect the power cable or signal cable, always pull it by the plug. Never pull on the cable itself as this may cause fire or electric shock.

DO NOT TOUCH THE PLUG WITH WET HANDS

Pulling or inserting the plug with wet hands may cause electric shock.

WHEN YOU INSTALL THE MONITOR ON YOUR COMPUTER

Be sure the computer is strong enough to hold the weight of the monitor, otherwise, you may damage your computer.

CAREFUL! PROTECT YOUR HANDS AND FINGERS

Be careful not to hurt your fingers or hands when you change the height or the angle.

REMARK FOR 24/7 USAGE

This product is not specifically designed for 24/7 usage in all environments.

REMARK FOR WALL MOUNTING

This product is not designed for digital signage (electronic signboard) applications such as wall mounting.

OTHERS

ERGONOMIC RECOMMENDATIONS

To eliminate eye fatigue, do not operate the monitor against a bright background or in a dark room. For optimal viewing comfort, the monitor should be just below eye level and 40-60cm (16-24 inches) away from your eyes. When using the monitor over a prolonged time, a ten minute break every hour is recommended as looking at the screen continuously can cause eye strain.

SPECIAL NOTES ON LCD MONITORS

The following symptoms are normal with LCD monitors and do not indicate a problem.

NOTE

- When you first turn on the LCD monitor, the picture may not fit in the monitor area because of the type of computer that is used. In this case, adjust the picture position to the correct position.
- You may find slightly uneven brightness on the screen depending on the desktop pattern you use.
- Due to the nature of the LCD screen, an afterimage of the previous screen may remain after switching the image, when the same image is displayed for hours. In this case, the screen can be recovered slowly by changing the image or turning off the Power Switch for some hours.

CUSTOMER SERVICE

NOTE

- If you have to return your unit for service and the original packaging has been discarded, please contact your dealer or iiyama service center for advice or replacement packaging.

CLEANING

WARNING

- If you drop any materials or liquids such as water into the monitor when cleaning, unplug the power cable immediately and contact your dealer or iiyama service center.

CAUTION

- For safety reasons, turn off the power switch and unplug the monitor before you clean it.

NOTE

- To protect the LCD panel, do not scratch or rub the screen with a hard object.
- Never use any of the following strong solvents. These will damage the cabinet and the LCD screen.

| | |
|------------------|--------------------------|
| Thinner | Spray-type cleaner |
| Benzine | Wax |
| Abrasive cleaner | Acid or Alkaline solvent |

- Touching the cabinet with any product made from rubber or plastic for a long time may cause degeneration or loss of paint on the cabinet.

CABINET

Stains can be removed with a cloth lightly moistened with a mild detergent solvent. Then wipe the cabinet with a soft dry cloth.

LCD

Periodic cleaning with a soft dry cloth is recommended.

SCREEN

Don't use tissue paper etc. because these will damage the LCD screen.

BEFORE YOU OPERATE THE MONITOR

FEATURES

- ◆ Supports Resolutions up to 3440 × 1440
- ◆ High Contrast 3000:1 (Typical), Advanced Contrast Function Available, Brightness 300cd/m² (Typical)
- ◆ Moving Picture Response Time 0.4ms
- ◆ Supports AMD FreeSync™ Premium Technology
- ◆ Flicker - Free
- ◆ Blue Light Reducer
- ◆ Digital Character Smoothing
- ◆ USB Type-C / RJ45 - Connectors
- ◆ USB Power Delivery supports up to 65W
- ◆ 2 × 2W Stereo Speakers
- ◆ Standby Feature
- ◆ VESA Mounting Standard (100mm×100mm) Compliant
- ◆ Keyhole for Security Lock

CHECKING THE CONTENTS OF THE PACKAGE

The following accessories are included in your package. Check to see if they are enclosed with the monitor. If anything is missing or damaged, please contact your local iiyama dealer or regional iiyama office.

- | | | |
|---------------------------|----------------------|---------------------|
| ■ Power Cable* | ■ HDMI Cable | ■ DisplayPort Cable |
| ■ USB Cable (C to C) | ■ USB Cable (A to B) | ■ Stand-Neck |
| ■ Stand-Base with a screw | ■ Screwdriver | ■ Safety Guide |
| ■ Quick Start Guide | | |

CAUTION

- * The rating of the Power Cable enclosed in 120V area is 10A/125V. If you are using a power supply higher than this rating, then a power cable with a rating of 10A/250V must be used. However, all guarantees and warranties are void for any problems or damage caused by a power cable not supplied by iiyama.
An approved power cable greater or equal to H05VVVF, 3G, 0.75mm² must be used.

USING ARM OR STAND

CAUTION

- Before installation, make sure the display arm or desk arm stand is strong enough to hold the necessary weight of the monitor and the mount.
- Panel angle adjustment range : 23° upward and 5° downward

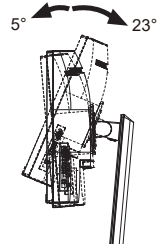

[DISPLAY ARM OR DESK ARM STAND]

CAUTION

- When you use with the display arm or desk arm stand, in consideration of thickness of the mounting stage, tighten the M4 Screws (4pcs) which "L" length is 8mm to fasten the monitor. Using the screw longer than this may cause electric shock or damage because it may contact with the electrical parts inside the monitor.

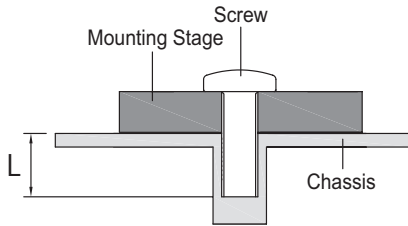

[LANDSCAPE MODE]

This monitor can only be used in landscape. Do not rotate or operate the monitor in any other orientation than landscape.

Available

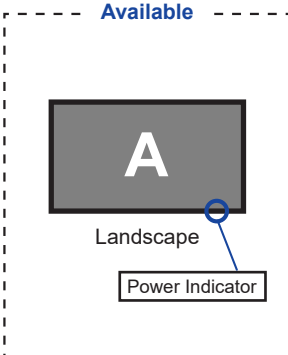

Not Available

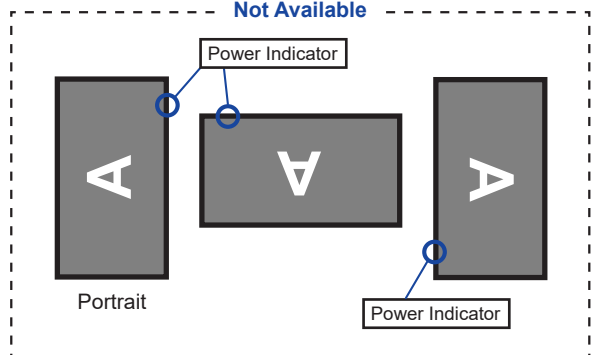

FITTING AND REMOVAL OF STAND

CAUTION

- Put the monitor on a stable surface. The monitor may cause injury or damage if it falls or is dropped.
- Do not give a strong impact to the monitor. It may cause damage.
- Unplug the monitor before removal or installation to avoid an electric shock or a damage.

<Installation>

- ① As shown below, place all the contents taken out from the carton box on a flat surface with the monitor front face down.
- ② Take off the rear cushion, Stand-Neck and Stand-Base.

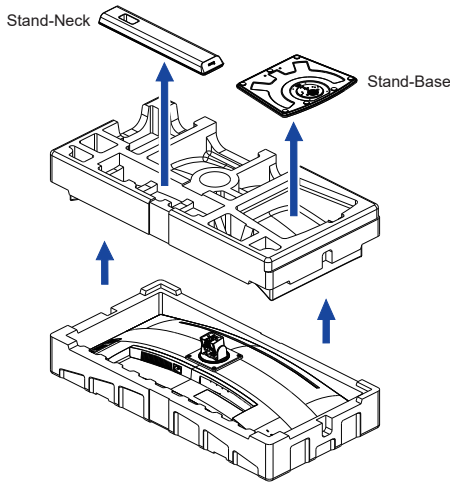

- ③ Install the Stand-Neck to the monitor and then tighten the 'thumb screw' with the provided screwdriver to secure them.

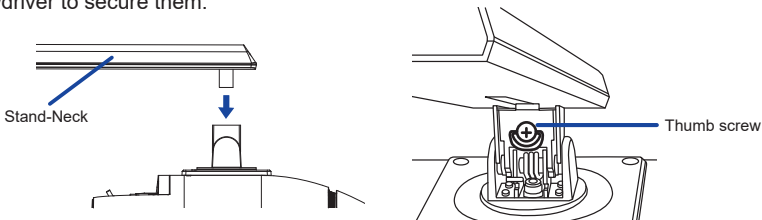

- ④ Install the Stand-Base to the Stand-Neck and then tighten the 'thumb screw' with the provided screwdriver to secure them.

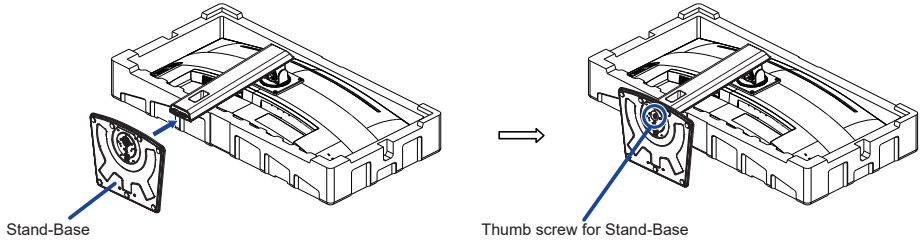

- ⑤ Stand the monitor and then remove the front cushion.

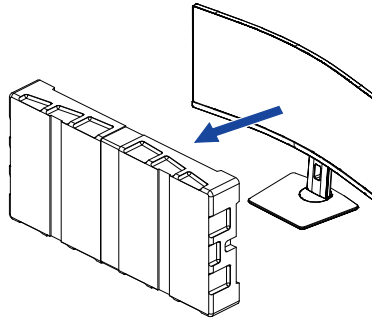

<Removal>

- ① Put the front cushion on a flat surface and place the monitor with face down on it.
- ② Loosen the 'thumb screw' with the provided screwdriver to remove the Stand-Base from the Stand-Neck.
- ③ Loosen the 'thumb screw' with the provided screwdriver to remove the Stand-Neck from the monitor.

CONTROLS AND CONNECTORS

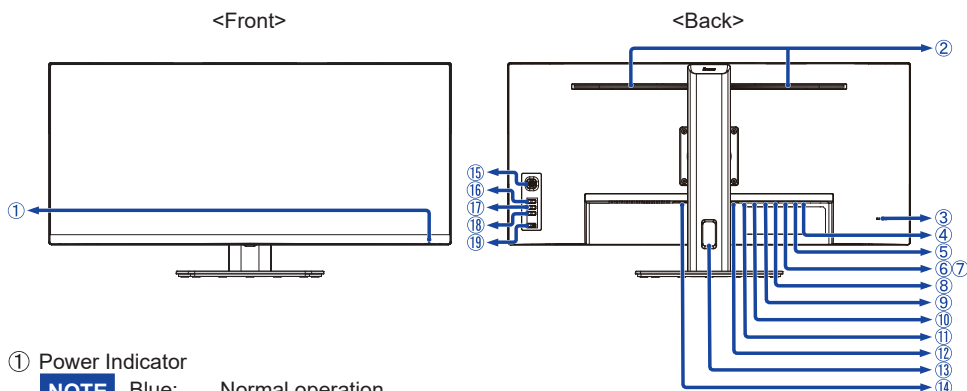

① Power Indicator

NOTE Blue: Normal operation
Orange: Standby mode

② Speakers

③ Keyhole for Security Lock

NOTE You can fasten a security lock and cable to prevent the monitor from being removed without your permission.

④ Headphone Connector ()

⑤ USB Downstream Connector () (USB3.2 Gen 1: 5Gbps, 5V, 900mA)

⑥ USB Downstream Connector () (USB3.2 Gen 1: 5Gbps, 5V, 900mA)

⑦ USB Downstream Connector () (USB3.2 Gen 1: 5Gbps, 5V, 900mA)

⑧ USB Upstream Connector ()

⑨ LAN(RJ45) Connector ()

⑩ USB Upstream Connector (USB-C) (USB3.2 Gen 1: 5Gbps, 20V, 3.25A)

⑪ DisplayPort Connector (DP)

⑫ HDMI Connector (HDMI)

⑬ Cable Hole

⑭ AC Connector (~ : Alternating current)

⑮ Navigation Button

Menu [Center]

Up []

Down []

Left / Eco [] *1,2

Right / Blue Light Reducer [] *1,2

⑯ Signal Select Button (INPUT) *1

⑰ Volume + Button (VOL +) *1

⑱ Volume – Button (VOL –) *1

⑲ Power Button ()

*1 You can skip the Menu items and directly display an option setting screen or an adjustment scale.

*2 Direction when viewing the screen from the front

CONNECTING YOUR MONITOR

- ① Ensure that both the computer and the monitor are switched off.
 - ② Connect the computer to the monitor with the signal cable.
 - ③ Connect the computer to the monitor with the USB Cable (A to B).
 - ④ Connect the computer to the monitor with the USB Cable (C to C) when viewing images on your monitor through the USB Type-C Connector or when using the monitor's USB hub function.*
 - ⑤ Connect the Power Cable to the monitor first and then to the power source.
 - ⑥ Turn on your monitor and computer.
- * ● When charging connected device via USB Type-C Connector, check if the device is equipped with a USB Type-C Connector that supports charging function via USB PD (=Power Delivery).
- The USB power delivery is up to 65W. If the connected device required more than 65W for operation or for boot up (when the battery is drained), use the original power adapter that came with the device.
 - If a separately purchased USB Type-C Cable is used, make sure the cable is certified by USB-IF and is full-featured with power delivery and video / audio / data transfer functions.
 - If the monitor is in standby mode, it will not display a picture automatically in the following situations:
 1. First boot of the PC
 2. When the PC is resuming from standby mode
 To display a picture, press the INPUT Button. This behaviour is normal. To prevent this behaviour, please access the OSD menu and set "USB Standby mode" to "OFF".
 - USB C to A cable is not included with the monitor. If you use a USB C to A cable, please note that you can only transfer data.
 - Compatibility with all connected devices is not guaranteed due to different user environments.

NOTE

- Make sure that the building installation has a circuit breaker of 120/240V, 20A (maximum).
- The signal cables used for connecting the computer and monitor may vary with the type of computer used. An incorrect connection may cause serious damage to both the monitor and the computer. The cable supplied with the monitor is for a standard connector. If a special cable is required please contact your local iiyama dealer or regional iiyama office.
- The Class I pluggable equipment Type A must be connected to protective earth.
- The socket-outlet shall be installed near the equipment and shall be easily accessible.
- Excessive sound pressure from ear-/headphones can cause hearing damage/hearing loss.

[Example of Connection]

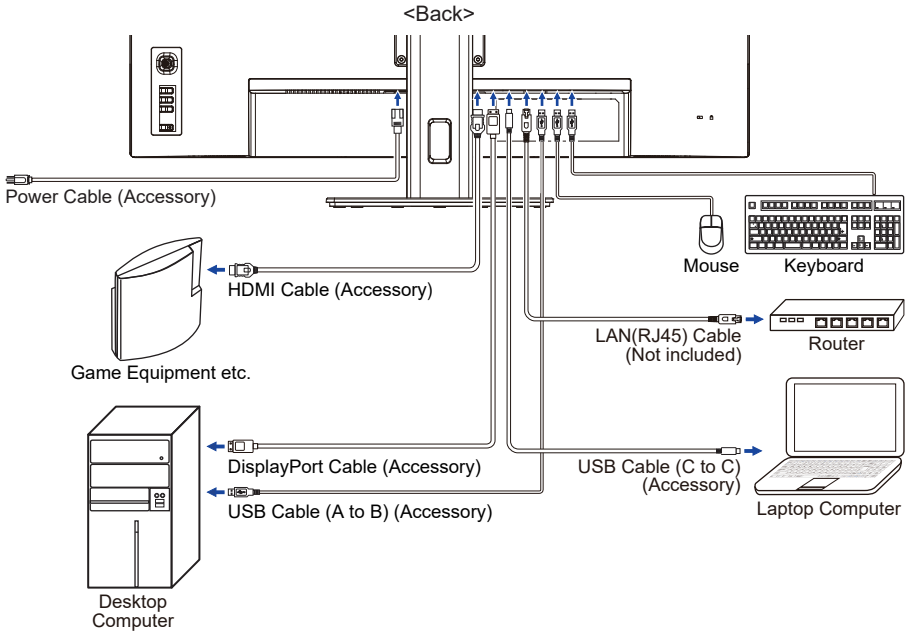

[Collect Cables]

Put the cables through the Cable Hole to bundle them.

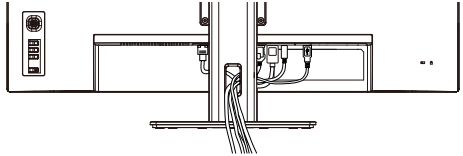

COMPUTER SETTING

■ Signal Timing

Change to the desired signal timing listed on page 28: COMPLIANT TIMING.

ADJUSTING THE HEIGHT AND THE VIEWING ANGLE

- For optimal viewing it is recommended to position yourself directly opposite to the full face of the monitor, then adjust the monitor's height and angle to your own preference.
- Hold the panel so that the monitor does not topple when you change the monitor's height or angle.
- You are able to adjust the monitor's height up to 150mm, angle up to 23° upward and 5° downward.

NOTE

- Do not touch the LCD screen when you change the height or the angle. It may cause damage or break the LCD screen.
- Careful attention is required not to pinch your fingers or hands into the moving part of the stand when you change the height or the angle.
- Injury can occur if care is not taken to avoid finger contact with the displays base when adjusting the height.

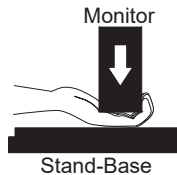
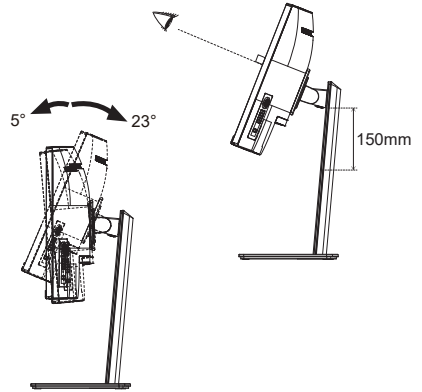

OPERATING THE MONITOR

To create the best picture, your iiyama LCD monitor has been preset at the factory with the COMPLIANT TIMING shown on page 28. You are also able to adjust the picture by following the button operation shown below.

- ① Press the Navigation Button [Center] on the monitor to start the On Screen Display feature. There are additional Menu items which can be switched by the Navigation Button [↔/↔].



- ② Select the Menu item which contains the adjustment icon relating to the adjustment you want to make. Press the Navigation Button [Center]. Then, press the Navigation Button [↕/↕] to highlight the desired adjustment icon.
- ③ Press the Navigation Button [Center] again. Press the Navigation Button [↔/↔] to make the appropriate adjustment or setting.
- ④ Press the Navigation Button [Center] and then press the INPUT Button to leave the menu, and the settings you just made would be automatically saved.

For example, to correct for OSD vertical position, select Menu item of Setup Menu and then press the Navigation Button [Center]. Then, select OSD Vertical Position by pressing the Navigation Button [↕/↕].

An adjustment scale becomes active after you press the Navigation Button [Center]. Then, press the Navigation Button [↔/↔] to change the OSD vertical position settings. The OSD vertical position of the overall display should be changing accordingly while you are doing this.

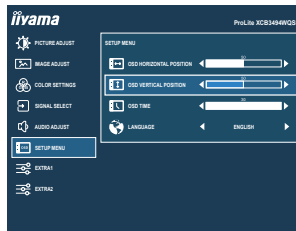







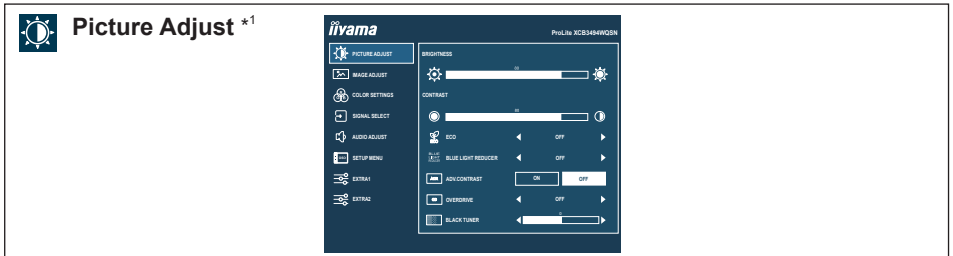

Press the Navigation Button [Center] and finally the INPUT Button to close the On Screen Display feature. All changes are saved in the memory.

NOTE

- When Button operations are aborted during adjustment, On-Screen Display disappears when the time set for the OSD Time has passed. Also, the INPUT Button can be used to return previous menu and turn off the On Screen Display.
- Any changes are automatically saved in the memory when the On Screen Display disappears. Turning off the power should be avoided while using the Menu.

ADJUSTMENT MENU CONTENTS



| Adjustment Item | Problem / Option | Navigation Button |
|---|--|--|
| Brightness *2 | Too dark Too bright |   |
| Contrast | Too dull Too intense |   |
| Eco Direct | Off | Normal |
| | Mode1 | Brightness of back-light is reduced. |
| | Mode2 | Brightness of back-light is reduced more than Mode1. |
| | Mode3 | Brightness of back-light is reduced more than Mode2. |
| Blue Light Reducer Direct | Off | Normal |
| | Mode1 | Blue light is reduced. |
| | Mode2 | Blue light is reduced more than 1. |
| | Mode3 | Blue light is reduced more than 2. |
| Adv. Contrast | On | Increased Contrast Ratio |
| | Off | Typical Contrast Ratio |
| Overdrive *3 | Off / 1 / 2 / 3 / 4 / 5 It will improve the gray level response time of the LCD panel. A higher level results in a faster response time. |   |
| Black Tuner | From -5 to +5 You can adjust Dark shades. |   |

NOTE Adv. Contrast adjusts brightness according to the image, and improve the contrast ratio during movie playing.

*1 The availability of each item depends on which item is activated. See page 23 "Function Correlation Matrix" for more details.
 *2 Adjust the Brightness when you are using the monitor in a dark room and feel the screen is too bright.
 *3 When Overdrive is activated, some level of image retention will be caused.

Direct

You can skip the Menu items and directly display an option setting screen by using the following button operations.

- Eco: Press the Navigation Button Left [↶] when the Menu is not displayed.
- Blue Light Reducer: Press the Navigation Button Right [↷] when the Menu is not displayed.

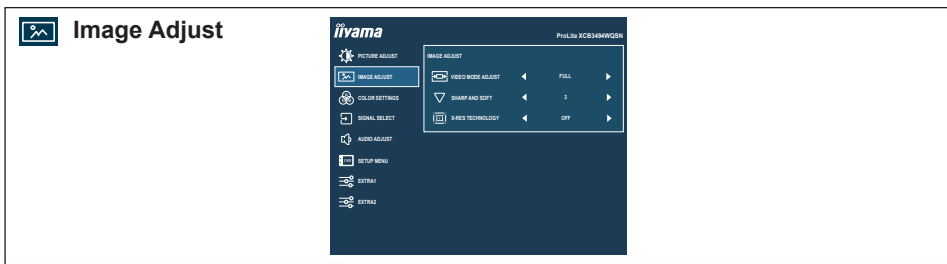

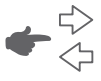
| Adjustment Item | Problem / Option | | Navigation Button |
|----------------------------------|--|---|--|
| Video Mode Adjust * ¹ | Full | Expansion display | |
| | Aspect | Expansion display of Aspect | |
| | Dot by Dot * ² | Display the picture dot by dot. | |
| Sharp and Soft | 1 2 3 4 5 6 You can change the picture quality from 1 to 6 (sharp to soft). Press Right [⇨] to change the picture quality in numerical order. Press Left [⇦] to change the picture quality in reverse numerical order. | |  |
| X-Res Technology * ³ | Off | Normal | |
| | Soft | Enhance the picture edge. | |
| | Middle | Enhance the picture edge more than the Soft option. | |
| | Hard | Enhance the picture edge more than the Middle option. | |

*¹ It can display in the center of the screen with a 4:3, 5:4 or 16:10 aspect ratio when input video resolution is 4:3, 5:4 or 16:10.

*² The availability of each item depends on which item is activated. See page 23 "Function Correlation Matrix" for more details.

*³ Disabled when HDR is active.



Color Settings *

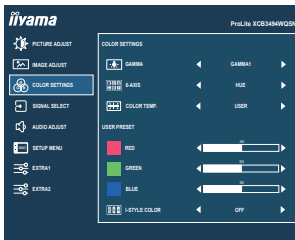

ENGLISH

| Adjustment Item | Problem / Option | | Navigation Button | |
|-----------------|------------------|--|---|--|
| Gamma | Gamma1 | Normal | | |
| | Gamma2 | Dark | | |
| | Gamma3 | High contrast | | |
| 6-Axis | Hue | Red | Too weak Too strong | |
| | | Yellow | | |
| | | Green | | |
| | | Cyan | | |
| | | Blue | | |
| | Saturation | Red | Too weak Too strong | |
| | | Yellow | | |
| | | Green | | |
| | | Cyan | | |
| | | Blue | | |
| Color Temp. | User | Red | Too weak Too strong | |
| | | Green | | |
| | | Blue | | |
| | sRGB | sRGB | | |
| | Warm | Warm color | | |
| | Normal | Normal color | | |
| | Cool | Cool color | | |
| | i-Style Color | Off | Return to a state set by color adjustment except i-Style Color. | |
| Standard | | For general windows environment and monitor default setting. | | |
| Text | | For text editing and viewing in a word processing environment. | | |
| Internet | | For internet environment. | | |
| Game | | For PC game environment. | | |
| Sports | | For sport environment. | | |

NOTE

- sRGB is an international standard which defines and unifies the difference of color appearance between equipment.
- Contrast, Eco, Blue Light Reducer, Adv. Contrast, Black Tuner, Gamma, 6-Axis and i-Style Color are locked during sRGB mode and cannot be adjusted.

* The availability of each item depends on which item is activated. See page 23 "Function Correlation Matrix" for more details.

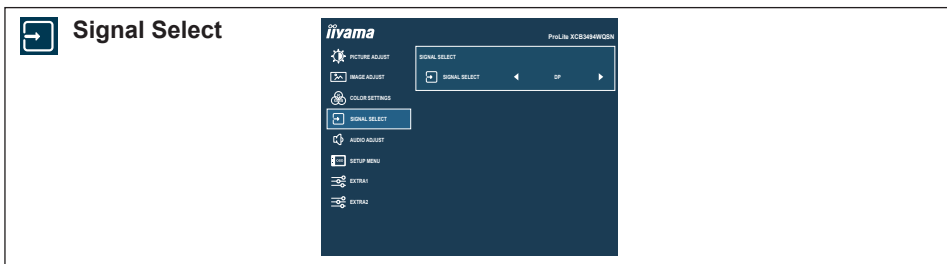

| Adjustment Item | Problem / Option | |
|-----------------------------|------------------|---|
| Signal Select Direct | AUTO | Select the signal input automatically. |
| | HDMI | Select the Digital (HDMI) input. |
| | DP | Select the Digital (DisplayPort) input. |
| | USB-C | Select the Digital (USB Type-C) input. |





NOTE At selected the AUTO, it will automatically be selected when just one source is available. If there are more input sources available and you select one of them, the AUTO option is not available. If multiple inputs are connected, the monitor may not recover the last one used after turning it off and on again. It is only possible when you set a specific source.

Direct

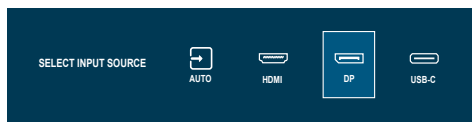
You can skip the Menu items and directly display an option setting screen by using the following button operations.

- Signal Select: Press the INPUT Button when the Menu is not displayed, it shows following Menu.



| Adjustment Item | | Problem / Option | Navigation Button |
|-----------------|---------------|--|--|
| Volume | Direct | Too soft Too loud |     |
| Mute | On | Turn off the sound temporarily. | |
| | Off | Return the sound volume to the previous level. | |

Direct

You can skip the Menu items and directly display an adjustment scale by using the following button operations.

- Volume: Press the VOL + / VOL – Buttons when the Menu is not displayed.





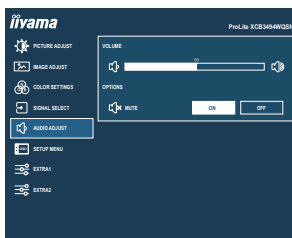





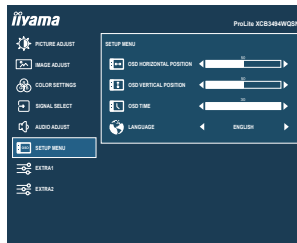



Audio Adjust





Setup Menu



| Adjustment Item | Problem / Option | | Navigation Button | |
|-------------------------|---|----------|--|------------|
| OSD Horizontal Position | OSD is too left OSD is too right | |     | |
| OSD Vertical Position | OSD is too low OSD is too high | |     | |
| OSD Time | You can set the OSD display duration time between 5 and 30 seconds. | |     | |
| Language | English | English | Nederlands | Dutch |
| | Deutsch | German | Polski | Polish |
| | Español | Spanish | Português | Portuguese |
| | Français | French | Русский | Russian |
| | Italiano | Italian | Česky | Czech |
| | 日本語 | Japanese | | |

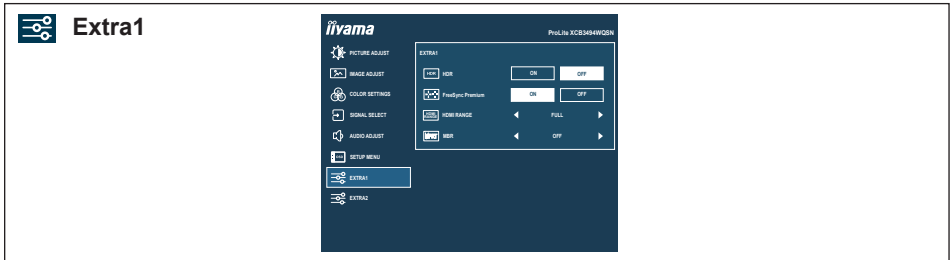

| Adjustment Item | Problem / Option | | Navigation Button |
|---------------------------------|---------------------------------|--|-------------------|
| HDR * ¹ | On | For HDR (High Dynamic Range) signal | |
| | Off | For normal signal | |
| FreeSync Premium * ¹ | On | Enable the FreeSync function. | |
| | Off | The FreeSync function is turned off. | |
| HDMI Range | Full | For full-range color scale signal. | |
| | Limited | For limited color scale signal. | |
| | Auto | Select the HDMI Range automatically. | |
| MBR * ^{1,2} | Off / 1 / 2 / 3 / 4 / 5 / 6 / 7 | Improve the moving picture response time of the LCD panel. | |

*¹ The availability of each item depends on which item is activated. See page 23 "Function Correlation Matrix" for more details.

*² MBR is available only when the refresh rate is 75Hz or more.



Extra2

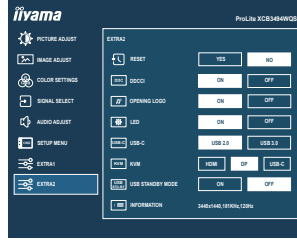

| Adjustment Item | Problem / Option | | |
|---|---|---|--|
| Reset | Yes | Factory-preset data is restored. | |
| | No | Return to Menu. | |
| DDCCI | On | DDC/CI is On. | |
| | Off | DDC/CI is Off. | |
| Opening Logo | On | Opening Logo is On. | |
| | Off | Opening Logo is Off. | |
| LED | On | The Power Indicator is turned On. | |
| | Off | The Power Indicator is turned Off. | |
| <p>NOTE Turn Off the Power Indicator when you are bothered by the light.</p> | | | |
| USB-C | USB 2.0 | Select the data transfer speed when connecting via USB Type-C. | |
| | USB 3.0 | | |
| <p>NOTE When USB 3.0 is selected on USB Type-C input, 3440 × 1440 resolution at 100Hz / 120Hz cannot be supported.</p> | | | |
| KVM | HDMI | USB-B | When two or three computers are connected to the monitor, you can link the input source with the USB upstream connector. |
| | | USB-C | |
| | DP | USB-B | |
| | | USB-C | |
| USB-C | USB-B | | |
| | USB-C | | |
| USB Stanby mode | On | The USB hub enters into the standby mode in synchronization with the monitor. | |
| | Off | The USB hub remains activated if the monitor enters into the standby mode. | |
| Information | Displays information regarding the current input signal coming from the graphic card in your computer. | | |
| | <p>NOTE See your graphic card user guide for more information about changing the resolution and refresh.</p> | | |

● **Lock Mode:**

<OSD Menu>

If you turn on the monitor with pressing the Navigation Button [Center] while the monitor is off, the OSD Menu operations will be locked / unlocked.

<Power Button / OSD Menu>

If you keep pressing the Navigation Button [Center] for 10 seconds when the Menu is not displayed, the Power Button / OSD Menu operations will be locked / unlocked.

■ Function Correlation Matrix

| Selected item | | Picture Adjust | | | | | | Image Adjust | | | | Color Settings | | | | | | Extra1 | | | |
|----------------|--------------------|----------------|----------|-----|--------------------|---------------|-----------|--------------|-------------------|------------|-------|----------------|-----------|-------------|------|--------|------|---------------|-----|-------------------|-----|
| | | Brightness | Contrast | Eco | Blue Light Reducer | Adv. Contrast | Overdrive | Black Tuner | Video Mode Adjust | Dot by Dot | Gamma | 6-Axis | User sRGB | Color Temp. | Warm | Normal | Cool | i-Style Color | HDR | Free Sync Premium | MBR |
| Active item | Eco | - | ✓ | / | - | - | ✓ | ✓ | ✓ | ✓ | ✓ | ✓ | ✓ | ✓ | - | - | - | ✓ | - | ✓ | - |
| | Blue Light Reducer | ✓ | ✓ | - | / | - | ✓ | ✓ | ✓ | ✓ | ✓ | - | - | - | - | - | - | - | - | ✓ | - |
| Image Adjust | Adv. Contrast | - | - | - | - | / | ✓ | ✓ | ✓ | ✓ | ✓ | ✓ | ✓ | ✓ | ✓ | ✓ | ✓ | ✓ | ✓ | - | ✓ |
| | Video Mode Adjust | ✓ | ✓ | ✓ | ✓ | ✓ | ✓ | / | ✓ | ✓ | ✓ | ✓ | ✓ | ✓ | ✓ | ✓ | ✓ | ✓ | ✓ | ✓ | ✓ |
| Color Settings | Color Temp. sRGB | - | - | - | - | - | - | - | ✓ | - | - | ✓ | ✓ | ✓ | ✓ | ✓ | ✓ | ✓ | ✓ | ✓ | ✓ |
| | i-Style Color | - | - | - | - | - | - | - | ✓ | - | - | ✓ | ✓ | ✓ | ✓ | ✓ | ✓ | ✓ | ✓ | ✓ | ✓ |
| Extra1 | HDR | - | - | - | - | - | - | - | ✓ | - | - | - | - | - | - | - | - | - | - | ✓ | - |
| | FreeSync Premium | ✓ | ✓ | ✓ | ✓ | ✓ | ✓ | ✓ | - | ✓ | ✓ | ✓ | ✓ | ✓ | ✓ | ✓ | ✓ | ✓ | ✓ | ✓ | ✓ |
| | MBR | - | ✓ | - | - | - | - | ✓ | ✓ | ✓ | ✓ | ✓ | ✓ | ✓ | ✓ | ✓ | ✓ | ✓ | ✓ | ✓ | ✓ |

✓ : Available

- : Not available

STANDBY FEATURE

This product features the standby function. When activated, it automatically reduces unnecessary power consumption of the monitor when your computer is not in use.

There is a standby step the monitor takes as described below. The standby function, including any timer settings is configured by the operating system. Check your operating system manual for information on how this can be configured.

■ Standby Mode

When the video signal from the computer is off, the monitor enters into Standby Mode which reduces the power consumption to 0.5W or less*. The screen becomes dark, and the power indicator turns to orange. From Standby Mode, the image reappears in several seconds when either the keyboard or the mouse are touched again.

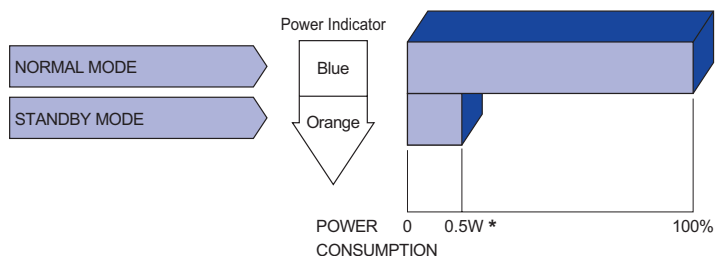

* When "USB Stanby mode" in the "Extra2" menu is On.

TROUBLE SHOOTING

If the monitor fails to operate correctly, please follow the steps below for a possible solution.

1. Perform the adjustments described in OPERATING THE MONITOR, depending on the problem you have. If the monitor does not get a picture, skip to 2.
2. Consult the following items if you cannot find an appropriate adjustment item in OPERATING THE MONITOR or if the problem persists.
3. If you are experiencing a problem which is not described below or you cannot correct the problem, discontinue using the monitor and contact your dealer or iiyama service center for further assistance.

| Problem | Check |
|--|---|
| ① The picture does not appear. (Power indicator does not light up.) (Power indicator is blue.) (Power indicator is orange.) | <input type="checkbox"/> The Power Cable is firmly seated in the socket. <input type="checkbox"/> The Power Switch is turned ON. <input type="checkbox"/> The AC socket is live. Please check with another piece of equipment. <input type="checkbox"/> If the blank screen saver is in active mode, touch the keyboard or the mouse. <input type="checkbox"/> Increase the Contrast and/or Brightness. <input type="checkbox"/> The computer is ON. <input type="checkbox"/> The Signal Cable is properly connected. <input type="checkbox"/> The signal timing of the computer is within the specification of the monitor. <input type="checkbox"/> If the monitor is in standby mode, touch the keyboard or the mouse. <input type="checkbox"/> The computer is ON. <input type="checkbox"/> The Signal Cable is properly connected. <input type="checkbox"/> The signal timing of the computer is within the specification of the monitor. |
| ② The screen is not synchronized. | <input type="checkbox"/> The Signal Cable is properly connected. <input type="checkbox"/> The signal timing of the computer is within the specification of the monitor. |
| ③ The screen position is not in the center. | <input type="checkbox"/> The signal timing of the computer is within the specification of the monitor. |
| ④ The screen is too bright or too dark. | <input type="checkbox"/> The video output level of the computer is within the specification of the monitor. |

Problem

Check

- | | |
|---------------------------------------|--|
| ⑤ The screen is shaking. | <input type="checkbox"/> The power voltage is within the specification of the monitor. |
| | <input type="checkbox"/> The signal timing of the computer is within the specification of the monitor. |
| ⑥ No sound. | <input type="checkbox"/> The audio equipment (computer etc.) is ON. |
| | <input type="checkbox"/> The Volume is turned up. |
| | <input type="checkbox"/> The Mute is OFF. |
| | <input type="checkbox"/> The audio output level of the audio equipment is within the specification of the monitor. |
| ⑦ The sound is too loud or too quiet. | <input type="checkbox"/> The audio output level of the audio equipment is within the specification of the monitor. |

RECYCLING INFORMATION

For better environment protection please don't dispose your monitor.
Please visit our web site: <https://iiyama.com> for monitor recycling.

APPENDIX

Design and specifications are subject to change without prior notice.

SPECIFICATIONS : ProLite XCB3494WQSN-B5

| | | |
|--|--|--|
| Size Category | 34" | |
| LCD Panel | Panel technology | VA |
| | Size | Diagonal: 34" (86.4cm) |
| | Curvature | 1500R |
| | Pixel pitch | 0.232mm H × 0.232mm V |
| | Brightness | 300cd/m ² (Typical), 160cd/m ² (Default / Energy Saving) |
| | Contrast ratio | 3000 : 1 (Typical), Advanced Contrast Function Available |
| | Viewable angle | Right / Left: 89° each, Up / Down: 89° each (Typical) |
| | MPRT | 0.4ms |
| Display Colors | Approx. 16.7 Million | |
| Sync Frequency | HDMI (FreeSync: Off): Horizontal: 30.0-185.0kHz Vertical: 30-120Hz (2560 × 1440 or less) 30-100Hz (3440 × 1440) HDMI (FreeSync: On): Horizontal: 30.0-185.0kHz Vertical: 48-120Hz (2560 × 1440 or less) 48-100Hz (3440 × 1440) DisplayPort / USB Type-C: Horizontal: 30.0-185.0kHz Vertical: 48-120Hz | |
| Native Resolution | 3440 × 1440, 4.9 MegaPixels | |
| Supported max. resolution | HDMI: 3440 × 1440 100Hz 2560 × 1440 120Hz DisplayPort / USB Type-C: 3440 × 1440 120Hz | |
| Input Connector | HDMI, DisplayPort, USB Type-B, USB Type-C (Alt Mode) | |
| Input Video Signal | HDMI, DisplayPort, USB Type-C (Alt Mode) | |
| USB Standard | USB3.2 Gen 1 (5Gbps, DC5V, 900mA), USB Power Delivery (65W) | |
| Number of USB Ports Connector shape | 2 Upstream: Type-B, Type-C 3 Downstream: Type-A | |
| LAN Port | RJ45 | |
| Headphone Connector | ø 3.5mm mini jack (Stereo) | |
| Speakers | 2W × 2 (Stereo speakers) | |
| Maximum Screen Size | 797.22mm W × 333.72mm H / 31.4" W × 13.1" H | |
| Power Source | 100-240VAC, 50/60Hz, 1.5A | |
| Power Consumption*1 | 56W typical (40W typical in factory configuration) Standby mode: 0.5W maximum, Off mode: 0.3W maximum | |
| Dimensions*2, Net Weight | 809.5 × 431.0 - 581.0 × 245.5(239.5)mm / 31.9 × 17.0 - 22.9 × 9.7(9.4)" (W×H×D), 9.4kg / 20.7lbs | |
| Height Adjustment Range | 150mm | |
| Tilt Angle | Upward: 23 degrees, Downward: 5 degrees | |
| Environmental Considerations | Operating: Temperature 5 to 35°C / 41 to 95°F Humidity 10 to 80% (No condensation) Storage: Temperature -20 to 60°C / -4 to 140°F Humidity 5 to 85% (No condensation) | |
| Approvals | CE, UKCA, TÜV-Bauart, EAC, VCCI, PSE | |

NOTE *1 When "USB Stanby mode" in the "Extra2" menu is On.

*2 () : Depth of the Stand-Base

DIMENSIONS

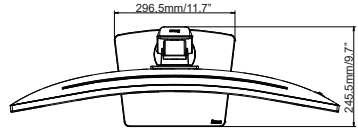
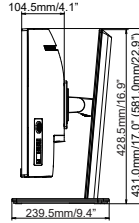
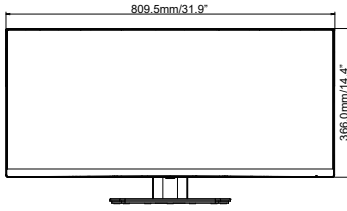

() : Maximum adjustment range

COMPLIANT TIMING

| Video Mode | Horizontal Frequency | Vertical Frequency | Dot Clock |
|-------------|----------------------|--------------------|------------|
| 800 × 600 | 37.879kHz | 60.317Hz | 40.000MHz |
| | 46.875kHz | 75.000Hz | 49.500MHz |
| 1024 × 768 | 48.363kHz | 60.004Hz | 65.000MHz |
| | 60.023kHz | 75.029Hz | 78.750MHz |
| 1280 × 1024 | 63.981kHz | 60.020Hz | 108.000MHz |
| | 79.976kHz | 75.025Hz | 135.000MHz |
| 1920 × 1080 | 67.500kHz | 60.000Hz | 148.500MHz |
| | 112.500kHz | 100.000Hz | 297.000MHz |
| | 135.000kHz | 120.000Hz | 297.000MHz |
| 2560 × 1440 | 88.860kHz | 60.000Hz | 241.699MHz |
| | 183.000kHz | 120.000Hz | 497.760MHz |
| 3440 × 1440 | 43.830kHz | 30.000Hz | 154.281MHz |
| | 88.860kHz | 60.000Hz | 319.896MHz |
| | 151.000kHz | 100.000Hz | 543.600MHz |
| | 181.200kHz | 120.000Hz | 652.320MHz |

NOTE *1 Available for HDMI input only.

*2 Available for DisplayPort and USB Type-C inputs only.

*3 In case of USB Type-C input, available only when "USB-C" in the "Extra2" menu is set to USB 2.0.

*4 The source graphic card must be capable of supporting 3440 × 1440 resolution at 60Hz / 100Hz / 120Hz.

| Console | 1080p (1920×1080) | 1440p (2560×1440) | 2160p (3840×2160) |
|-----------------|----------------------|----------------------|----------------------|
| PS5 | 60 / 120Hz | — | — |
| Xbox Series X/S | 60 / 120Hz | 120Hz | — |